

Joseph[®]
Joseph

Tota Trio

90-litre easy-empty laundry
separation basket





scan to see the video

Parts

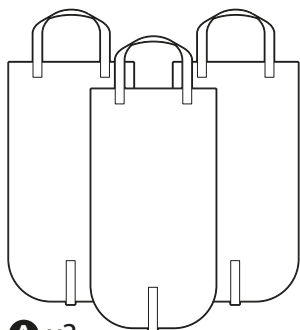

A x3

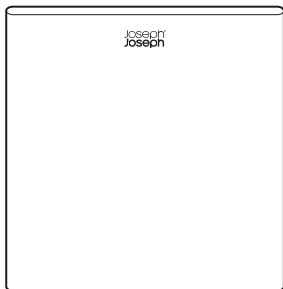

B x1

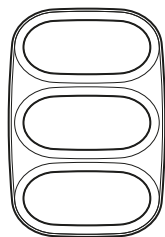

C x1

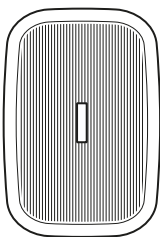

D x1

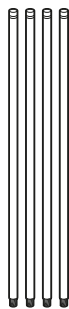

G x4



H x4

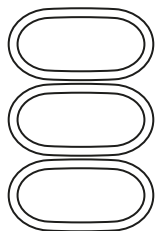

E x3

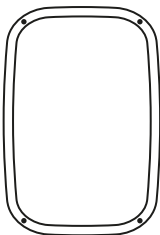

F x1



I x1

1

josephjoseph.com

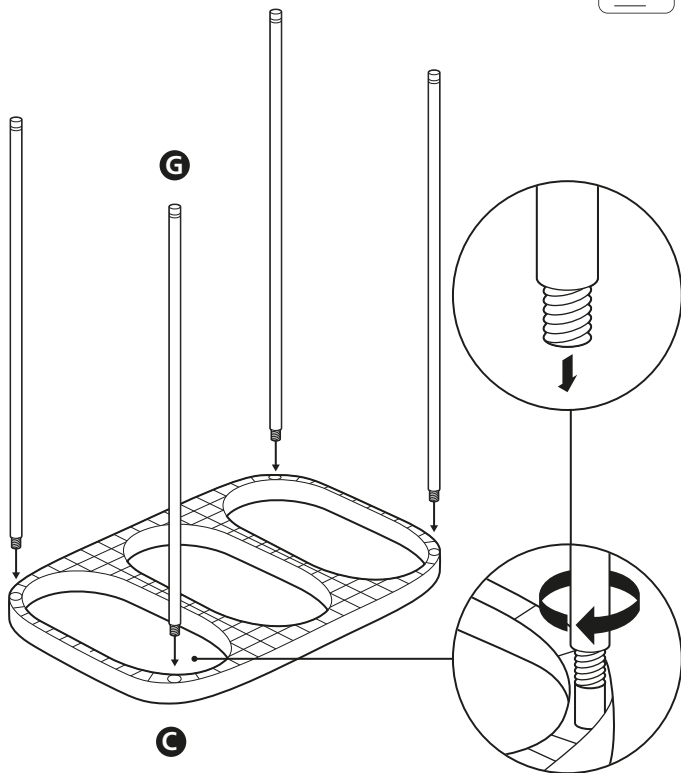

2

B

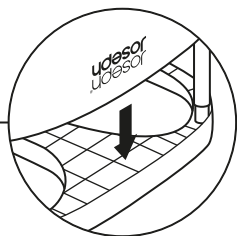
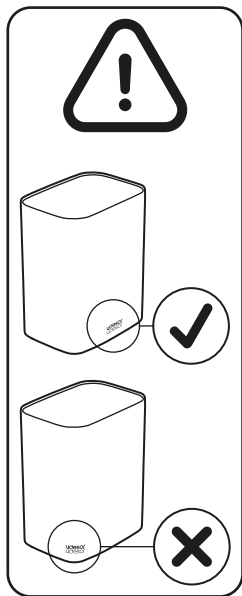
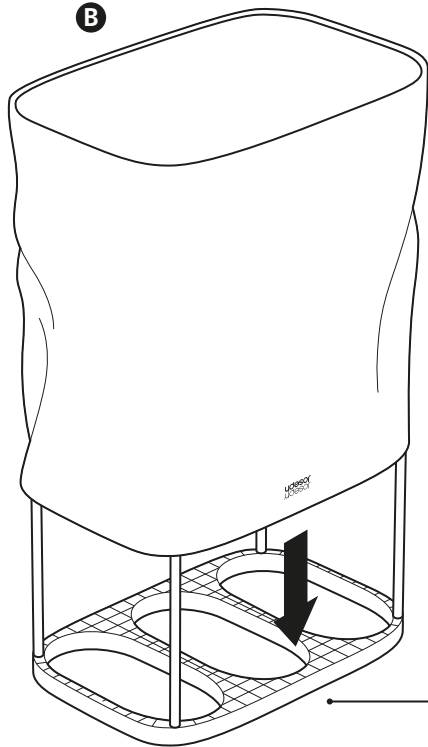

3

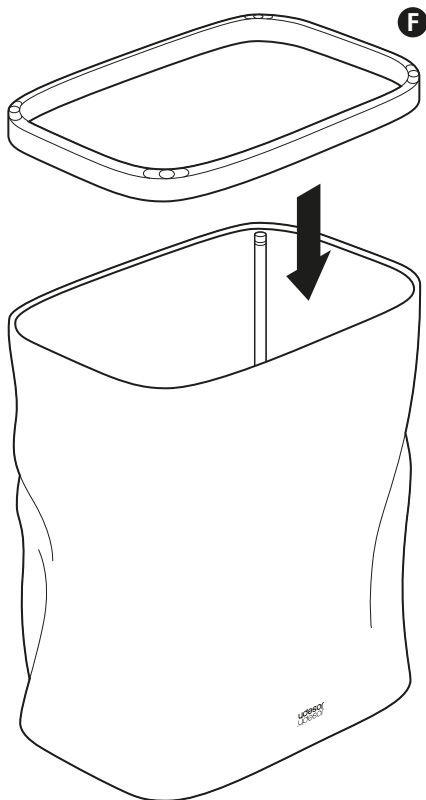

4

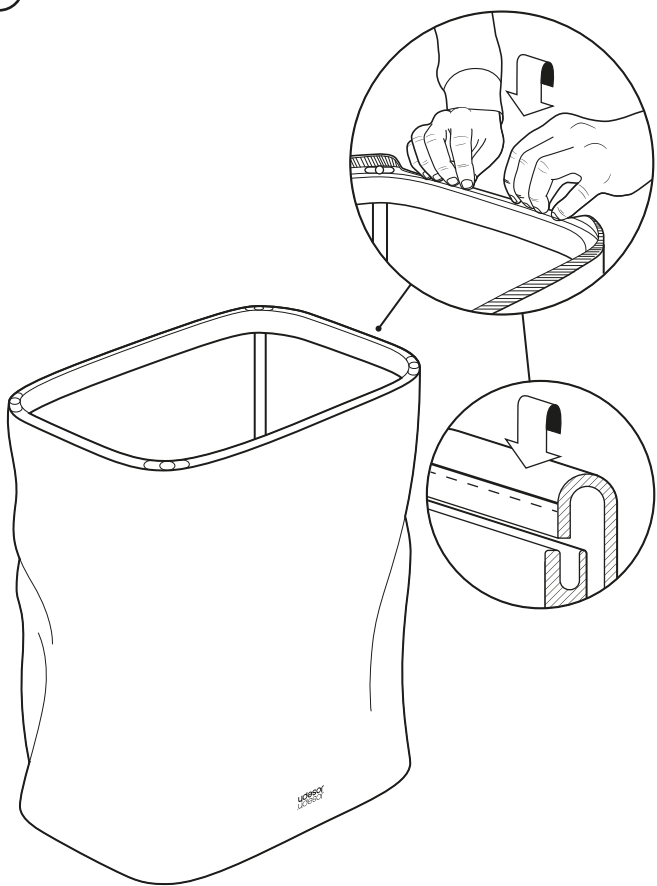

5

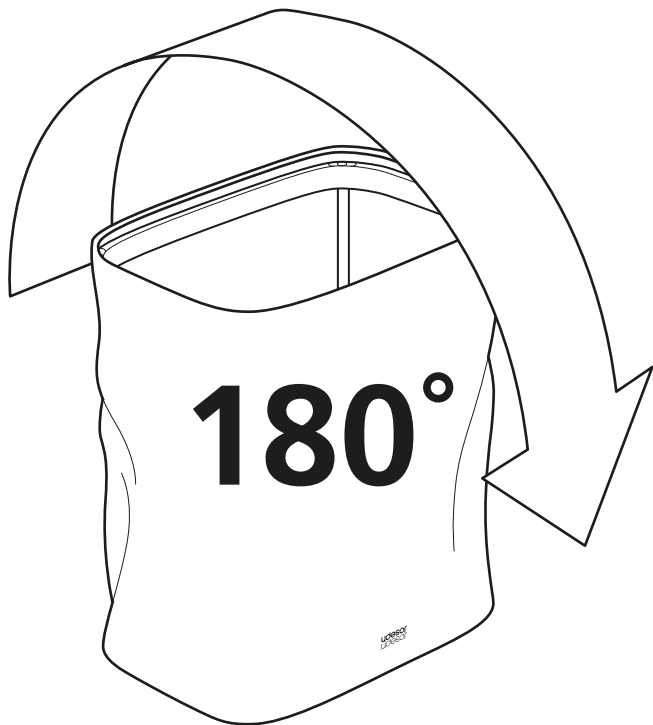

6

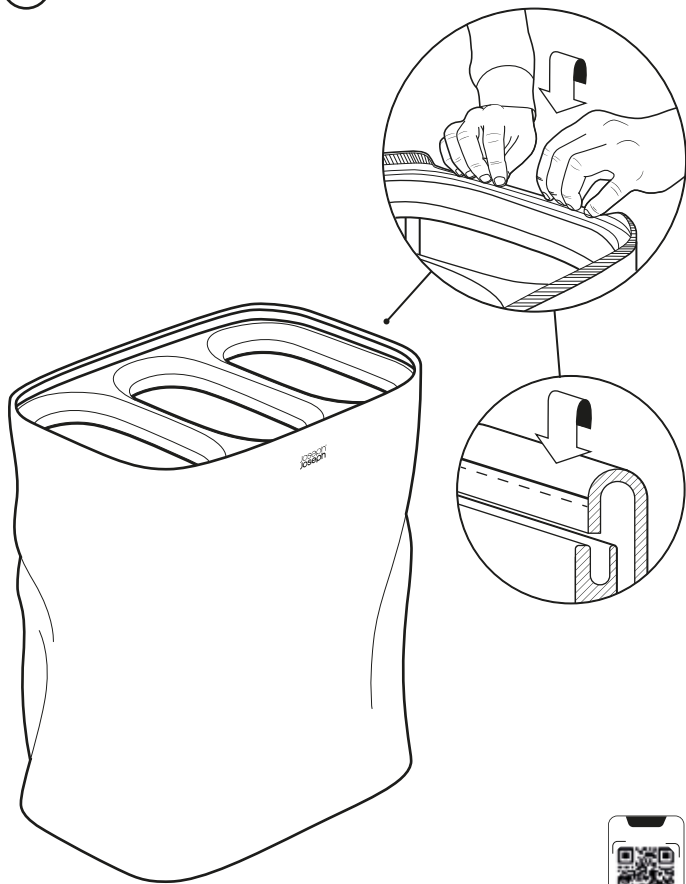

josephjoseph.com



7

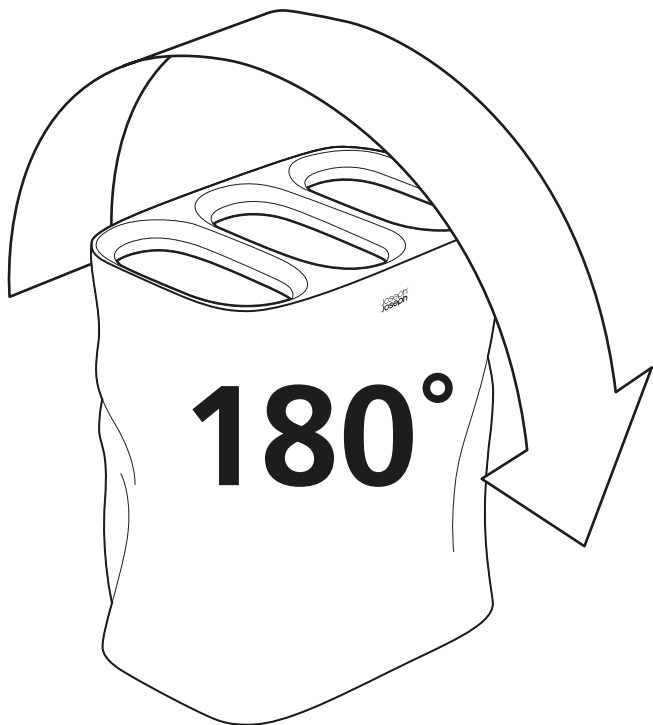

8

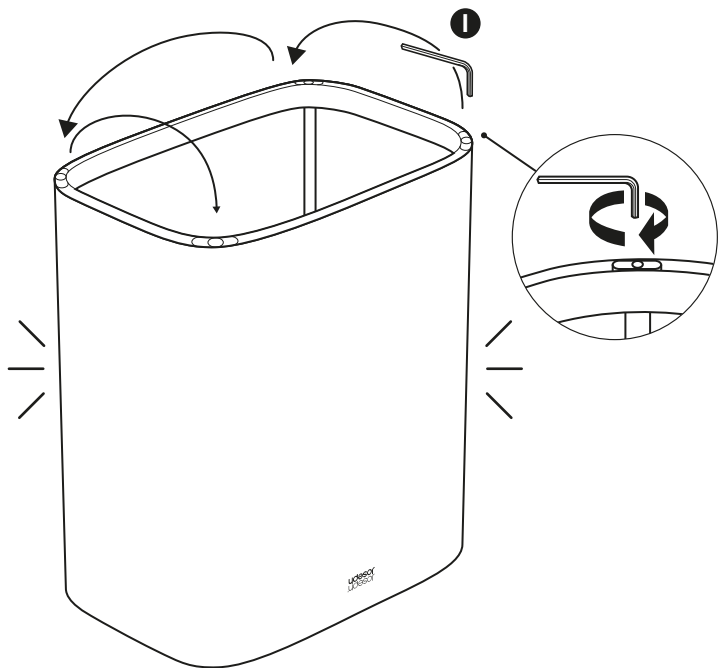
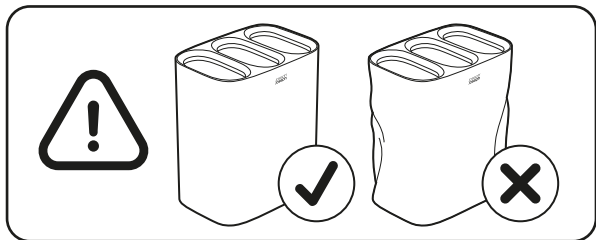

9

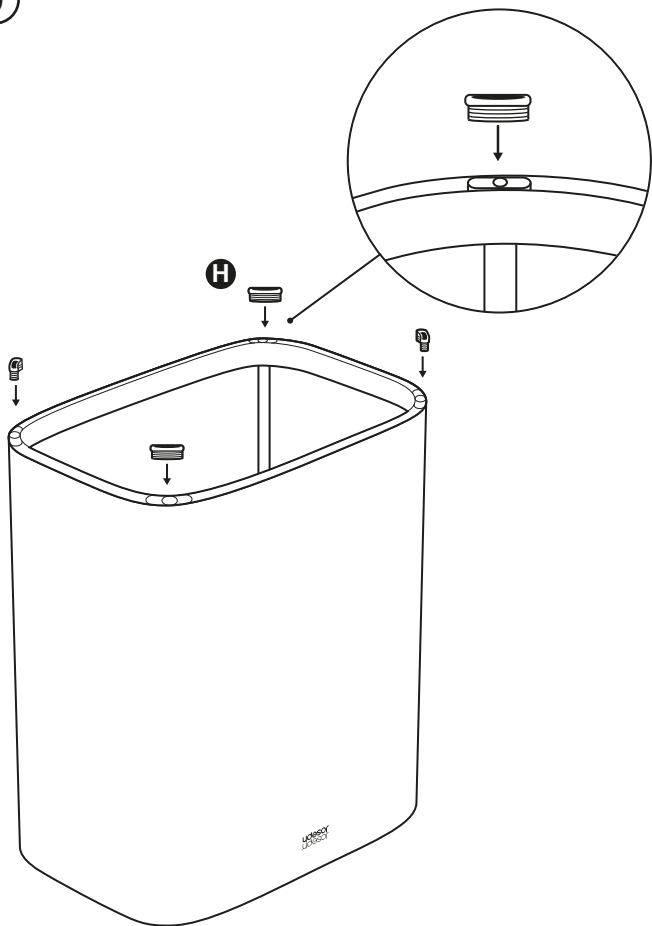

10

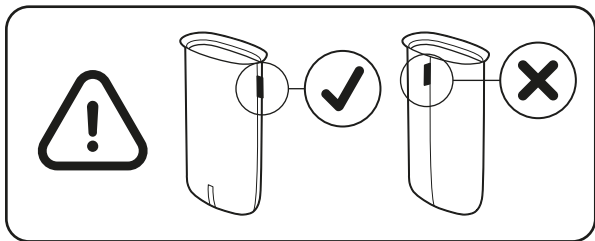

E



A

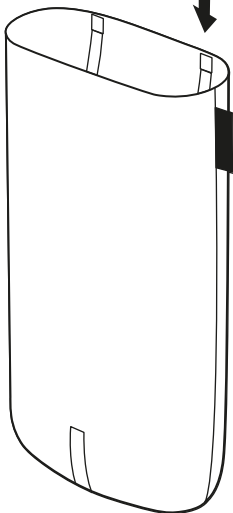

x3

11

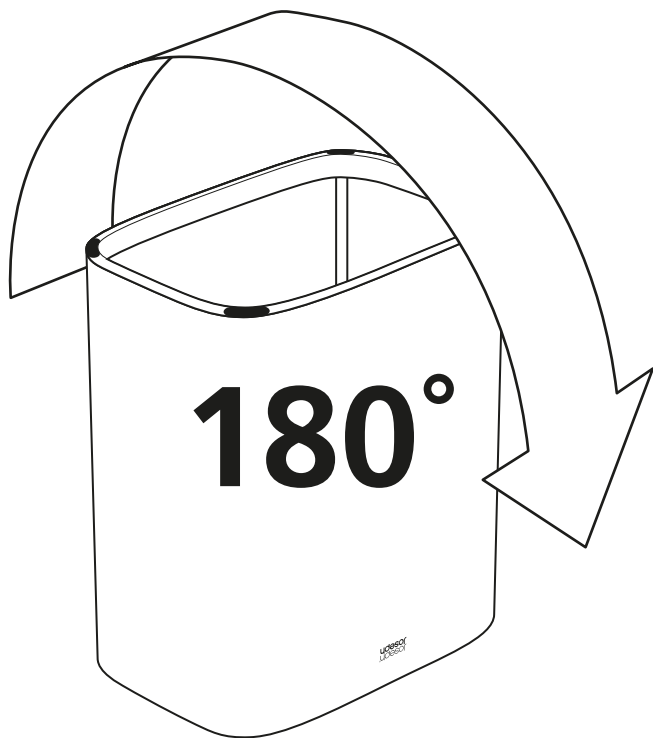

12

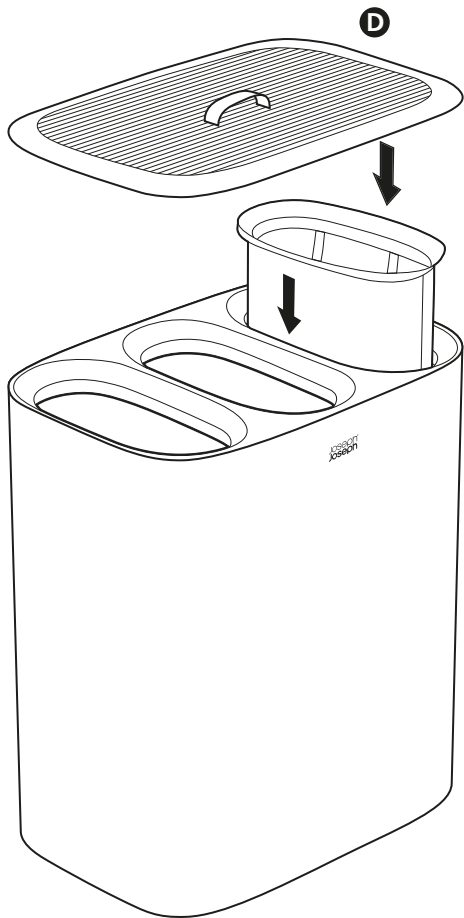

Care & Use

Entretien et utilisation / Pflegehinweis / Uso y cuidado / Conservação e utilização /
Uso e pulizia / 取扱上の注意事項 / 使用和保養

Tote bags: Machine washable – see label on product for instructions. Remove plastic rim before washing.

Fabric exterior: Wipe clean only – do not machine wash. **Lid, rims and frame:** Wipe clean with a damp

cloth. **Caution:** Do not sit or place heavy objects on basket. Do not allow children to play with basket.

FR

Sacs : Lavables en machine – voir les instructions sur l'étiquette du produit. Retirez l'élément en plastique avant de laver. **Extérieur en tissu :** Nettoyage à sec uniquement – ne pas laver à la machine. **Couvercle, bords et cadre :** Nettoyer à l'aide d'un chiffon humide. **Attention :** Ne pas s'asseoir ni placer des objets lourds sur le panier. Ne laissez pas des enfants jouer avec le panier.

ES

Bolsas: Lavar a máquina (consulte las instrucciones del producto en la etiqueta). Retirar el ribete de plástico antes de lavar. **Exterior de tela:** Limpiar únicamente con un paño. No lavar a máquina. **Tapa, bordes y estructura:** Limpiar con un paño húmedo. **Precaución:** No se sienta ni coloque objetos pesados sobre la cesta. No permita que los niños jueguen con la cesta.

IT

Sacche: Lavabili in lavatrice – vedi l'etichetta sul prodotto per le istruzioni. Rimuovere il bordo in plastica prima del lavaggio. **Tessuto esterno:** Pulire con un panno – non lavare in lavatrice. **Coperchio, bordo e telaio:** Pulire con un panno umido. **Attenzione:** Non mettere oggetti pesanti né sopra il cesto, né al suo interno. Non permettere ai bambini di giocare con il cesto.

CN

使用和保养大手提袋 : 可机洗 - 有关说明请参阅产品标签。清洗前移除塑料饰件。织物外观 : 仅擦拭 - 不可机洗。盖子、边缘和框架 - 用湿布擦拭干净。当心 : 不可坐卧或放置重物。不可供儿童玩耍。

DE

Tragetaschen: Maschinenwaschbar - siehe Etikett auf dem Produkt für Anweisungen. Entfernen Sie die Kunststoffverkleidung vor dem Waschen. Außen aus Stoff: Nur abwischen - nicht in der Maschine waschen. **Deckel, Felgen und Rahmen:** Mit einem feuchten Tuch abwischen. **Achtung:** Setzen Sie sich nicht oder stellen Sie keine schweren Gegenstände auf den Korb. Lassen Sie Kinder nicht mit dem Korb spielen.

PT

Sacos: Podem ir à máquina de lavar roupa, consultar as instruções nas respetivas etiquetas. Remover a parte de plástico antes de lavar. **Revestimento têxtil exterior:** Limpar só com um pano, não pode ir à máquina de lavar roupa. **Tampa, rebordo e estrutura:** Limpar com um pano húmido. **Cuidado:** Não sentar nem colocar objetos pesados em cima do cesto. Não permitir que crianças brinquem com o cesto.

JP

取扱上の注意事項: バッグは洗濯機で洗えます。製品の洗濯表示ラベルをご確認ください。プラスチックのパーツは洗濯前に取り外してください。ランドリーバスケット外側の布地部分は乾拭きしてください。洗濯機は使用できません。蓋・リム・フレームは湿った布で汚れをふいてください。ご注意: バスケットの上に座ったり重いものを置いたりしないでください。お子様がバスケットで遊ばないようお気を付けてください。

Joseph Joseph Ltd.
100 Union Street,
London SE1 1NL,
United Kingdom.
www.josephjoseph.com

Joseph Joseph Deutschland GmbH
Königsallee 92a – 4.Stock,
40212 Düsseldorf,
Germany / Alemania / Alemanha

Joseph Joseph Inc.
41 Madison Avenue
15th Floor,
New York, NY 10010

Joseph Joseph 株式会社
Tel. 0570-031-117
カスタマーサービス受付時間:
10:00~12:00 / 13:00~18:00
(土・日・祝日を除く)